

# Katalog

Februar 2014

# Catalog

February 2014



# Speed

SpeedDimension GmbH  
Gretlade 5  
31319 Höver, Germany  
Tel. +49(0)5132 / 86 87-15  
Fax +49(0)5132 / 86 87-44  
info@speeddimension.com  
www.speeddimension.com

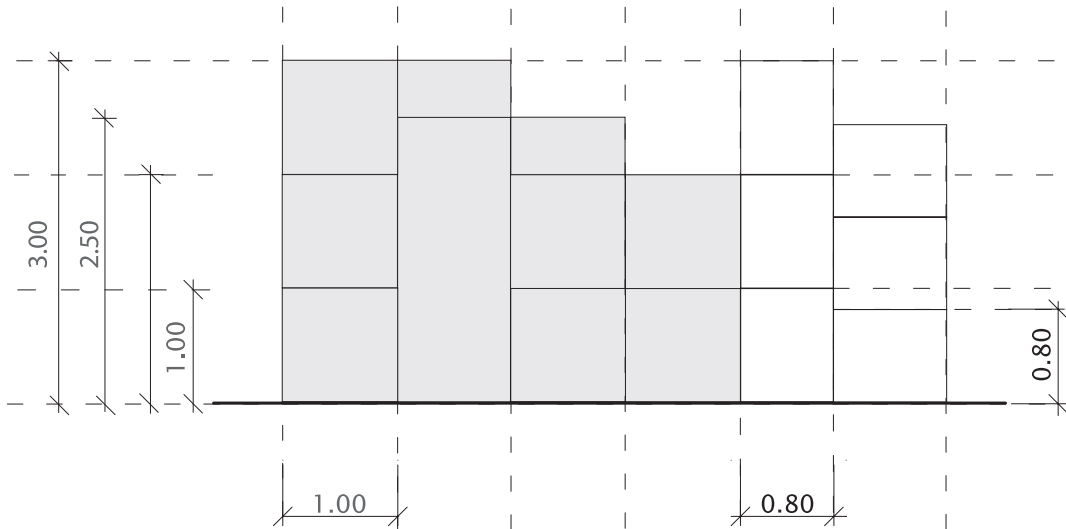
Beispiel für Bauhöhenkombination  
Example of overall height combination



Mustergrundriss  
Plan view example

- Winkelstütze  
Square column 
- Winkelstütze  
Triangle column 
- Wandelement 1.000 mm  
Wall unit 1.000 mm 
- Wandelement 800 mm  
Wall unit 800 mm 
- Wandelement 500 mm  
Wall unit 500 mm 
- Regalboden 1.000 mm  
Shelve 1.000 mm 

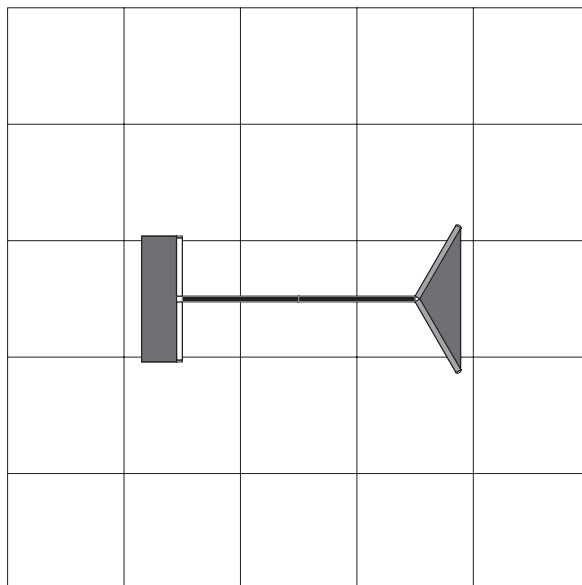

# Übersicht Overview

## Grundrahmen und Zubehör Basic frame and accessories

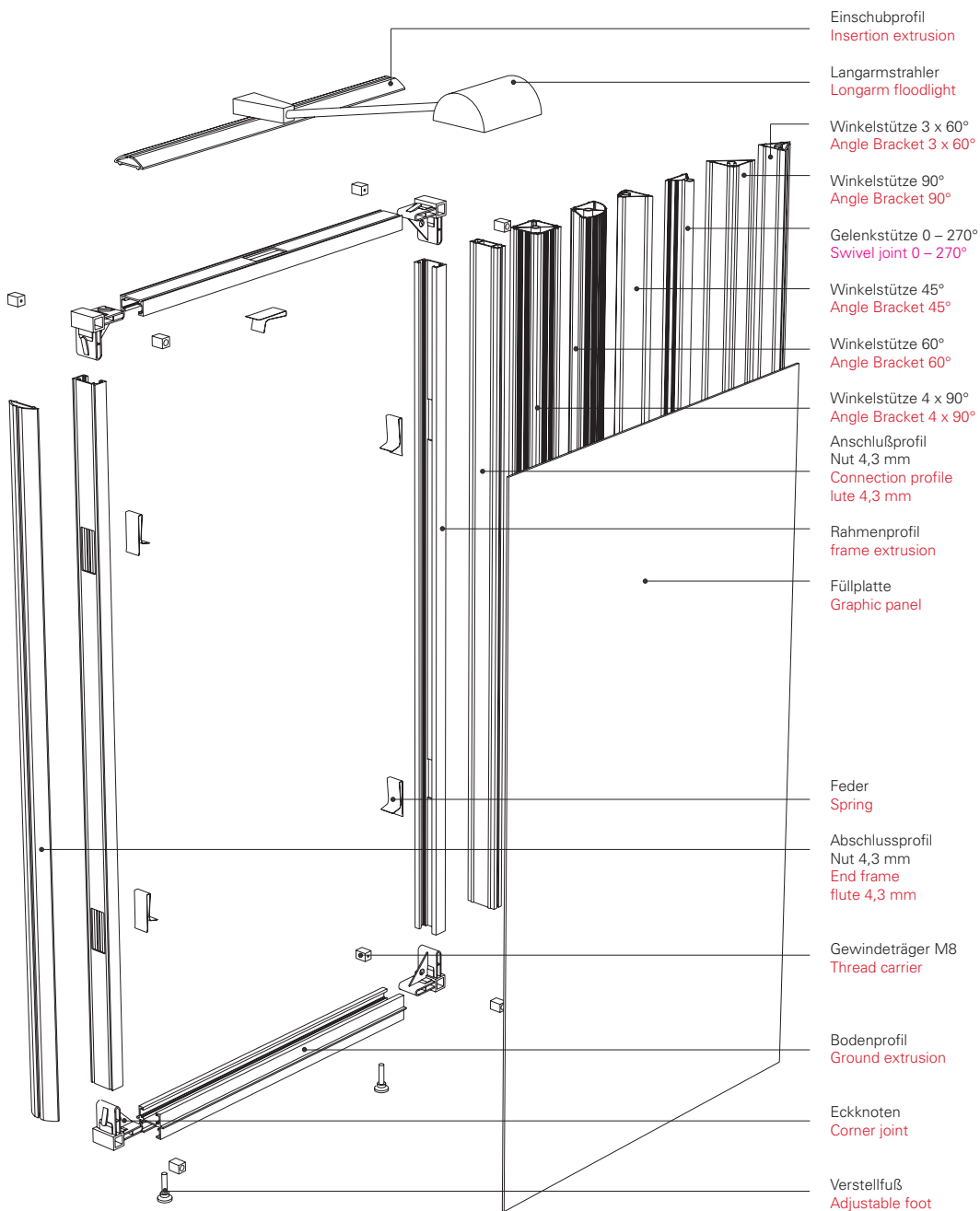

Speed Up

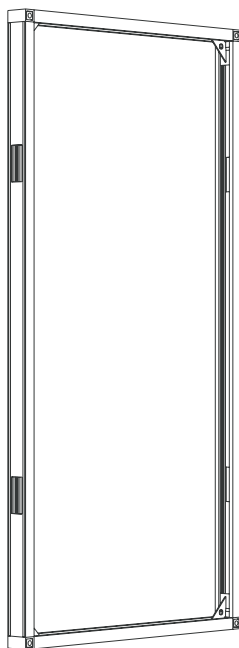
Rahmen  
Frames

Inkl. Magnetband und Eckknoten  
Incl. magnetic tape and corner joint

Rahmen  
Frame

Breite Width	Höhe Height	Bestell-Nr. Order No.
500 mm	500 mm	RAUP050.050
800 mm	500 mm	RAUP080.050
1.000 mm	500 mm	RAUP100.050
800 mm	1.000 mm	RAUP080.100
1.000 mm	1.000 mm	RAUP100.100

Aufpreis für 4 Gewindehülsen  
Additional charge for 4  
screw nuts

EKUP000.001

Weitere Maße auf Anfrage.  
Dissentient dimensions on request.

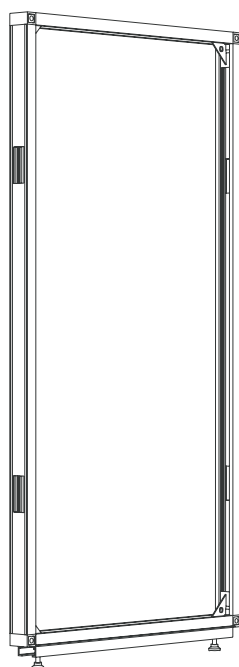

Inkl. Magnetband und Eckknoten  
und Füßen  
Incl. magnetic tape and corner joint

Rahmen mit Bodenprofil  
Frame with adjustable feet

Breite Width	Höhe Height	Bestell-Nr. Order No.
500 mm	1.000 mm	RAUP050.101
800 mm	1.000 mm	RAUP080.101
1.000 mm	1.000 mm	RAUP100.101

Aufpreis für 4 Gewindehülsen  
Additional charge for 4  
screw nuts

EKUP000.001

Weitere Maße auf Anfrage.  
Dissentient dimensions on request.

SpeedUp

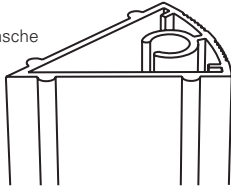
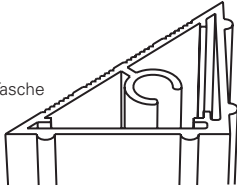
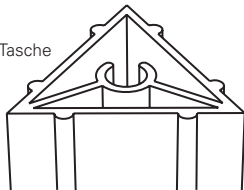
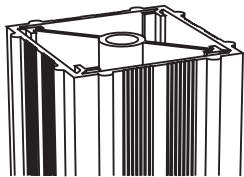
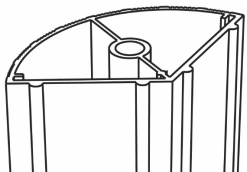
2-seitige Tasche  
2-sidedStützen  
ohne FüÙe  
und Verbindungsbolzen (Seite 5 und 7)  
Brackets without feet and extension bolt  
(page 5 and 7)Winkelstütze 45°  
Angle Bracket 45°Länge  
Length500 mm  
1.000 mmBestell-Nr.  
Order No.WSUP245.050  
WSUP245.1002-seitige Tasche  
2-sidedStützen  
ohne FüÙe und Verbindungs-  
bolzen (Seite 5 und 7)  
Brackets without feet and extension bolt  
(page 5 and 7)Winkelstütze 90°  
Angle Bracket 90°Länge  
Length500 mm  
1.000 mmBestell-Nr.  
Order No.WSUP290.050  
WSUP290.1003-seitige Tasche  
3-sidedStützen  
ohne FüÙe und Verbindungsbolzen  
(Seite 5 und 7)  
Brackets without feet and extension bolt  
(page 5 and 7)Winkelstütze 3 x 60°  
Angle Bracket 3 x 60°Länge  
Length500 mm  
1.000 mmBestell-Nr.  
Order No.WSUP003.050  
WSUP003.1003-seitige  
Tasche  
3-sidedStützen  
ohne FüÙe und Verbindungsbolzen  
(Seite 5 und 7)  
Brackets without feet and extension bolt  
(page 5 and 7)Quadratstütze 1 x 90°  
Square Bracket 1 x 90°Länge  
Length500 mm  
1.000 mmBestell-Nr.  
Order No.WSUP490.050  
WSUP490.1002-seitige Tasche  
2-sidedStützen  
ohne FüÙe und Verbindungsbolzen  
(Seite 5 und 7)  
Brackets without feet and extension bolt  
(page 5 and 7)Winkelstütze 120°  
Angle Bracket 120°Länge  
Length500 mm  
1.000 mmBestell-Nr.  
Order No.WSUP120.050  
WSUP120.100

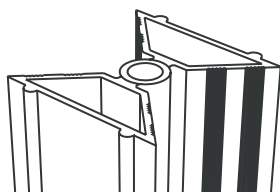
Stützen  
Columns

Gelenkstütze 0° x 270°  
Angle bracket 0° x 270°

Gelenkstütze Aluminium  
Angle bracket aluminium

Länge  
Length

500 mm  
1.000 mm

Bestell-Nr.  
Order No.

GEUP270.050  
GEUP270.100

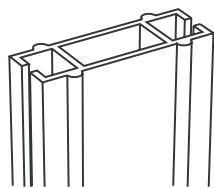

Nut 4,3 mm  
Flute 4,3 mm

Anschlussprofil eckig  
Connection profile

Länge  
Length

500 mm  
1.000 mm

Bestell-Nr.  
Order No.

ANUP000.050  
ANUP000.100

Nut 4,3 mm  
Flute 4,3 mm

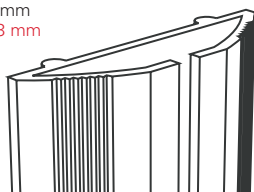

Abschlussprofil rund  
End frame round

Länge  
Length

500 mm  
1.000 mm

Bestell-Nr.  
Order No.

ABUP000.050  
ABUP000.100

SpeedUp

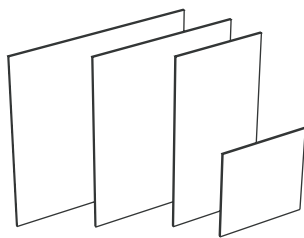

Farbig +15%  
Colored +15%

### Hartschaumplatte inkl. Stahlband+Folie Expanded plastic slab incl. steel band+foil

Breite Width	Länge Length	Bestell-Nr. Order No.
500 mm	500 mm	FOUP050.050
500 mm	1.000 mm	FOUP050.100
800 mm	1.000 mm	FOUP080.100
1.000 mm	1.000 mm	FOUP100.100



### Digitaldruck Digital print

Bestell-Nr.  
Order No.

ZUUP000.012

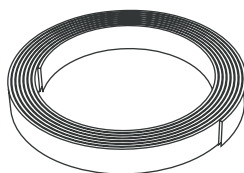

### Magnetband Magnetic tape roll

Breite Width	Länge Length	Bestell-Nr. Order No.
25 mm	1.000 mm	MAUP000.001

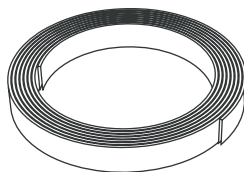

### Stahlband Steel tape roll

Breite Width	Länge Length	Bestell-Nr. Order No.
25 mm	1.000 mm	STUP000.001

## Platten Panels

SpeedUp

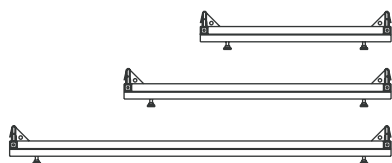
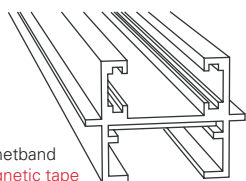
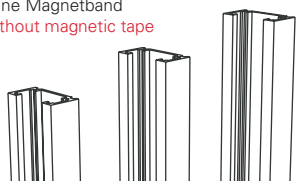
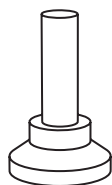
Bauteile des Grundrahmens  
Basic frame suppliesZubehör  
AccessoriesMit Eckknoten, Füßen und Magnetband  
With corner joint, feet and magnetic tapeBodenprofil  
Ground frameLänge  
Length500 mm  
800 mm  
1.000 mmBestell-Nr.  
Order No.BEUP000.050  
BEUP000.080  
BEUP000.100Mit Magnetband  
With magnetic tapeBodenprofil  
Ground profileLänge  
Length500 mm  
800 mm  
1.000 mmBestell-Nr.  
Order No.BOUP000.050  
BOUP000.080  
BOUP001.000Ohne Magnetband  
Without magnetic tapeBodenprofil  
Ground profileLänge  
Length500 mm  
800 mm  
1.000 mmBestell-Nr.  
Order No.RPUP000.050  
RPUP000.080  
RPUP001.000Stellfuß  
Adjustable footBestell-Nr.  
Order No.Bodenprofil  
Ground profile

FUUP000.001

Gelenkstütze  
Angle bracket

FUUP000.002

Sonstige Stützen  
Other brackets

FUUP000.003

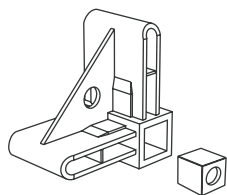
Eckknoten  
Corner jointGewindehülse  
Screw nutBestell-Nr.  
Order No.Eckknoten  
Corner joint

EKUP000.001

Inkl. Gewindehülsen  
Incl. screw nuts

EKUP000.002

Gewindehülse  
Screw nut

ZUUP000.004

SpeedUp



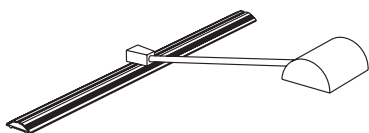

Mit Schiene und zwei Federn  
With frame and two clips

### Strahler LED silber Lamp LED silver

Breite Width	Länge Length	Bestell-Nr. Order No.
100 mm	500 mm	AS063 SU011

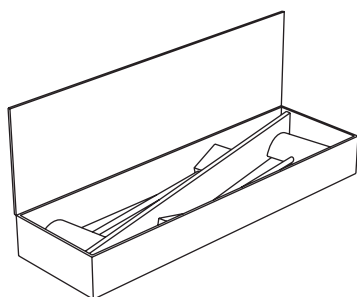

### Tasche für 2 Strahler Case for 2 halogen lamps

Breite Width	Länge Length	Bestell-Nr. Order No.
200 mm	670 mm	ZUUP000.002

Inkl. vier  
M8 Schrauben  
Incl. four  
M8 screws

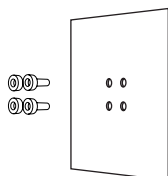

### Aussteifungsplatte Bracing plate

Breite Width	Länge Length	Bestell-Nr. Order No.
150 mm	150 mm	ZUUP000.003

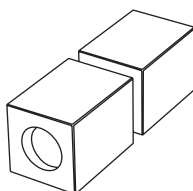

### Gewindehülsen Screw nut

Breite Width	Länge Length	Bestell-Nr. Order No.
13 mm	18 mm	ZUUP000.004

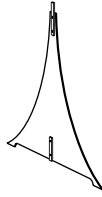

Stützfuß für Rahmen ganz  
Support foot for frame full

Breite Width	Länge Length	Bestell-Nr. Order No.
500 mm	600 mm	ZUUP000.005

rechts oder links  
right or left



Stützfuß für Rahmen halb  
Support foot for frame half

Breite Width	Länge Length	Bestell-Nr. Order No.
255 mm	600 mm	ZUUP000.006

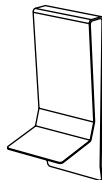

Feder  
Clip

Bestell-Nr. Order No.
FE000.001



Verlängerungsbolzen für Stütze  
Extension bolt for support foot

	Länge Length	Bestell-Nr. Order No.
Bolzen Bolt	50 mm	ZUUP000.008
Bolzen für Gelenkstütze Bolt for Angle bracket	50 mm	ZUUP000.008

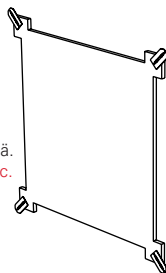

Für LCD Screens o.ä.  
For LCD screens etc.

Verstärkungsplatte  
Reinforcing plate for heavy items

Breite Width	Länge Length	Bestell-Nr. Order No.
958 mm	958 mm	ZUUP000.009

Tresenplatte 4-teilig  
Desk top in 4 parts

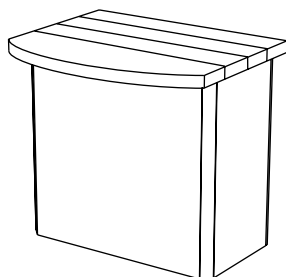

## SpeedDesk SpeedDesk

Breite Width	Länge Length	Bestell-Nr. Order No.
1.000 mm	100 mm	ZUUP000.010
		Rückwand und kaschierte Platten Rear panel and foil-coated
		ZUUP000.110
		Rückwand abschließbar Rear panel lockable
		ZUUP000.120
		2 Einlegeböden 2 shelves
		ZUUP000.130
		Rollkoffer Case with wheels
		ZUUP000.140

SpeedUp Stahlfuß d=5mm  
SpeedUp steel feet

Breite Width	Länge Length	Bestell-Nr. Order No.
1.000 mm	1.200 mm	SF003.150

Stahlfuß verstellbar  
von Mitte auf Seite  
Steel feet adjustable  
from center to side

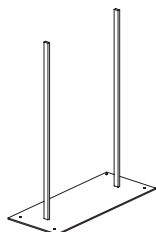

SpeedUp

Transporteinheiten  
Transportunits

Bestell-Nr.  
Order No.

Zubehör  
Accessories

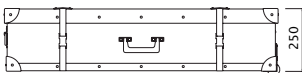
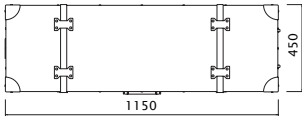
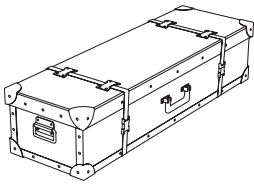

Rollkoffer für 6 Rahmen  
und Zubehör oder 1 Tresen  
Case with wheels for  
6 frames and accessories  
or 1 SpeedDesk

TRUP000.001

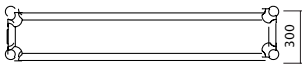
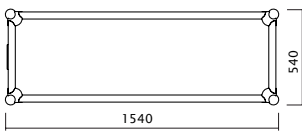
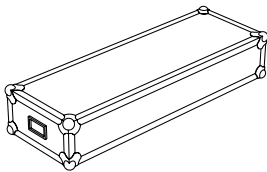

Flightcase für 6 Rahmen  
Flightcase for 6 frames

TRUP000.002

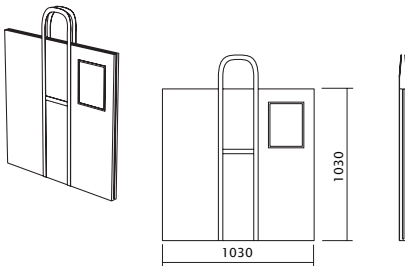

Transporttasche für  
12 Grafikplatten  
Bag for 12 panels

TRUP000.003

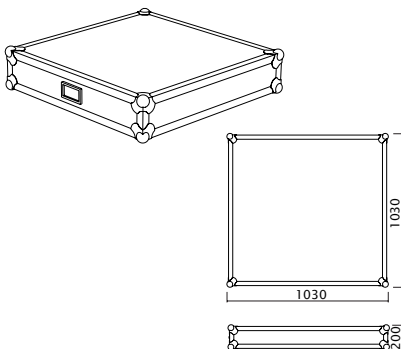

Flightcase für 12 Grafikplatten  
Flightcase for 12 panels

TRUP000.004

SpeedUp