



SpeedDimension GmbH / Gretlade 5, 31319 Höver, Germany  
Telefon +49(0)5132 – 86 87 15 / Fax +49(0)5132 – 86 87 44  
[www.speeddimension.com](http://www.speeddimension.com) / [info@speeddimension.com](mailto:info@speeddimension.com)

**Kaufpreise / Purchase prices**  
Mietpreise auf Anfrage / Rental prices on request  
Januar 2008 / January 2008



## DOPPELBODEN SPEEDFLOOR / EXHIBITION FLOORING SPEEDFLOOR

### Unterbodenkonstruktion / Floor Construction

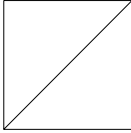
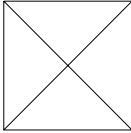
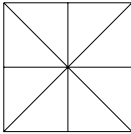
Holz Unterkonstruktion / Wooden Construction	Breite/ Width	Länge/ Length	Preis pro m <sup>2</sup> € <sup>*</sup> / Price per unit <sup>*</sup>	Bestell-Nr./ Order No.
 <div style="display: inline-block; vertical-align: middle;">normale Belastung / standard loading</div>	1000	1000	79,00 €	HU001.001
 <div style="display: inline-block; vertical-align: middle;">mittlere Belastung / medium loading</div>	1000	1000	129,00 €	HU001.002
 <div style="display: inline-block; vertical-align: middle;">schwere Belastung / heavy loading</div>	1000	1000	239,00 €	HU001.003

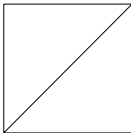
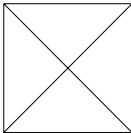
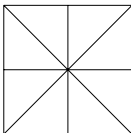
Aluminium Unterkonstruktion / Aluminium Construction	Breite/ Width	Länge/ Length	Preis pro m <sup>2</sup> € <sup>*</sup> / Price per unit <sup>*</sup>	Bestell-Nr./ Order No.
 <div style="display: inline-block; vertical-align: middle;">normale Belastung / standard loading</div>	1000	1000	79,00 €	AU001.001
 <div style="display: inline-block; vertical-align: middle;">mittlere Belastung / medium loading</div>	1000	1000	129,00 €	AU001.002
 <div style="display: inline-block; vertical-align: middle;">schwere Belastung / heavy loading</div>	1000	1000	239,00 €	AU001.003

\* ab einer Abnahme von 30 m<sup>2</sup>. Darunter auf Anfrage /

alle Maße in mm / all scales in mm

\* for quantities under 30m<sup>2</sup> contact us

## DOPPELBODEN SPEEDFLOOR / EXHIBITION FLOORING SPEEDFLOOR

### Bauteile des Doppelbodens / Basic flooring system elements

Stellfüsse/ Adjusting feet	Einzelpreis in €/ Price per unit	Bestell-Nr./ Order No.
 <p>Gewicht/lfdm / Weight 280 g 130-170 mm</p>	Mitte / Middle	19,50 € <span style="color: red;">SF002.001</span>
	Ecke / Corner	19,50 € <span style="color: red;">SF002.002</span>
	Seite / Side	19,50 € <span style="color: red;">SF002.003</span>

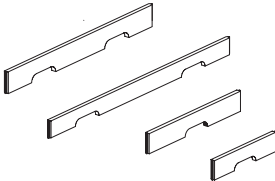
Zargen/ Frame parts, Multiplex	Länge/ Length	Einzelpreis in €/ Price per unit	Bestell-Nr./ Order No.
 <p>Gewicht/lfdm / Weight 800 g - 1600 g</p>	1400	19,80 €	<span style="color: red;">ZA002.004</span>
	1000	15,40 €	<span style="color: red;">ZA002.005</span>
	700	13,80 €	<span style="color: red;">ZA002.006</span>
	500	12,80 €	<span style="color: red;">ZA002.007</span>

Stellfüsse für Aluminiumzargen/ Adjusting feet for aluminium frame parts	Einzelpreis in €/ Price per unit	Bestell-Nr./ Order No.
 <p>Höhe/ Height 63-83 mm Gewicht/lfdm / Weight 130 g - 250 g</p>	Mitte / Middle	19,50 € <span style="color: red;">SF003.001</span>
	Ecke / Corner	19,50 € <span style="color: red;">SF003.002</span>
	Seite / Side	19,50 € <span style="color: red;">SF003.003</span>

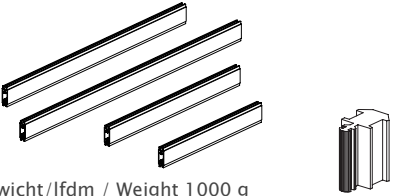
Aluminium Zargen, Zargenklipp/ Aluminium frame parts, clip for frame parts	Länge/ Length	Einzelpreis in €/ Price per unit	Bestell-Nr./ Order No.
 <p>Gewicht/lfdm / Weight 1000 g</p>	1400	18,90 €	<span style="color: red;">AZ003.004</span>
	1000	14,90 €	<span style="color: red;">AZ003.005</span>
	700	11,95 €	<span style="color: red;">AZ003.006</span>
	500	9,95 €	<span style="color: red;">AZ003.007</span>
		<span style="color: red;">KL000.010</span> Zargenklipp/ Clip for frame part 1,25 €	

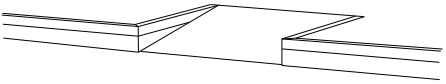
Rampe / Ramp	Breite/ Width	Länge/ Length	Einzelpreis in €/ Price per unit	Bestell-Nr./ Order No.
	1000	1000	189,00 €	<span style="color: red;">SR000.001</span>

alle Maße in mm/ all scales in mm

## DOPPELBODEN SPEEDFLOOR / EXHIBITION FLOORING SPEEDFLOOR

### Bauteile des Doppelbodens / Basic flooring system elements

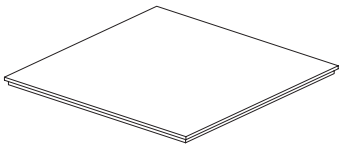
MFP-Platten (für Multiplex Zargen) 22 mm/ MFP Plates (for Multiplex Frames) 22 mm	Breite/ Width	Länge/ Length	Einzelpreis in €/ Price per unit	Bestell-Nr./ Order No.
 Gewicht/lfdm / Weight 1500 g	1000	1000	26,80 €	SP002.008
	1000	500	15,40 €	SP002.009
	500	500	12,80 €	SP002.010

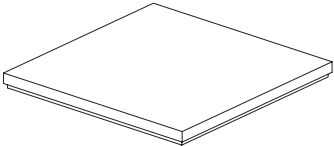
Sandwichplatte (für Aluminium Zargen) 44 mm/ Lightwood (for Aluminium Frames) 44 mm	Breite/ Width	Länge/ Length	Einzelpreis in €/ Price per unit	Bestell-Nr./ Order No.
 Gewicht/lfdm / Weight 1800 g	1000	1000	54,00 €	MP002.011
	1000	500	38,50 €	MP002.012
	500	500	27,50 €	MP002.013

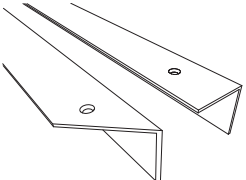
Abschlusskante aus Aluminium 60/60/3 Aluminium Border 60/60/3	Länge/ Length	Einzelpreis in €/ Price per unit	Bestell-Nr./ Order No.	
 Gewicht/lfdm / Weight 1400 g inkl. Aufdopplung und HDF Verblendung / incl. additional panels and facing	Gehrung / Miter	1033	32,50 €	AS080.133
		1000	28,00 €	AS080.100
		2000	56,00 €	AS080.200
		3000	84,00 €	AS080.200

alle Maße in mm/ all scales in mm

## DOPPELBODEN SPEEDFLOOR / EXHIBITION FLOORING SPEEDFLOOR

### Zubehör Doppelboden / Accessory for ground floor system

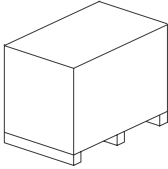
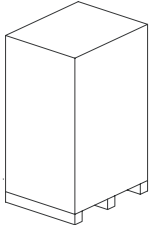
SpeedFloor Palette für 100 m <sup>2</sup> / Speed Floor pallet for 100 m <sup>2</sup>		Einzelpreis in €/ Price per unit	Bestell-Nr./ Order No.
    Gewicht/Weight 480 kg / 700 kg	Aluminium Zargen/ Aluminium frame parts Länge/ Breite/ Höhe Length/ Bright/ Height 1400/ 800/ 600 Gewicht/ Weight 480 kg	420,00 €	<b>SP000.010</b>
	Multiplex Zargen/ Multiplex frame parts Länge/ Breite/ Höhe Length/ Bright/ Height 1200/ 800/ 1750 Gewicht/ Weight 700 kg	635,00 €	<b>SP000.020</b>
			Palette ohne Einlegeplatten/ Pallet without plates

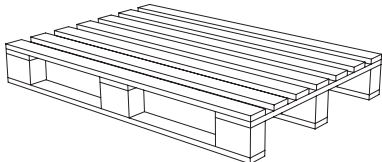
Palette für 40 m <sup>2</sup> Deckplatten / Palett for 40 m <sup>2</sup> plates	Breite/ Width	Länge/ Length	Einzelpreis in €/ Price per unit	Bestell-Nr./ Order No.
  Gewicht/lfdm / Weight 1 800 g	800	1200	28,00 €	<b>SF000.030</b>

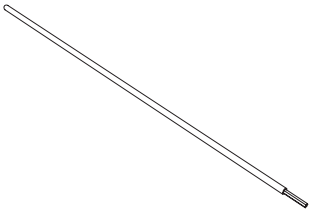
Justierwerkzeug zur Nivellierung der FüÙe / Tool for adjusting feet		Einzelpreis in €/ Price per unit	Bestell-Nr./ Order No.
		44,50 €	<b>ZU001.001</b>

alle Maße in mm/ all scales in mm