

# Preisliste Kaufpreise

zzgl. MwSt.  
März 2011  
Mietpreise auf  
Anfrage

# Price list Purchase prices

Excl. VAT  
March 2011  
Rental prices on re-  
quest

# Speed Mall

SpeedDimension GmbH  
Gretlade 5  
31319 Höver, Germany  
Tel. +49(0)5132 / 86 87-15  
Fax +49(0)5132 / 86 87-44  
info@speeddimension.com  
www.speeddimension.com

Beispiel für Bauhöhenkombination  
Example of overall height combination

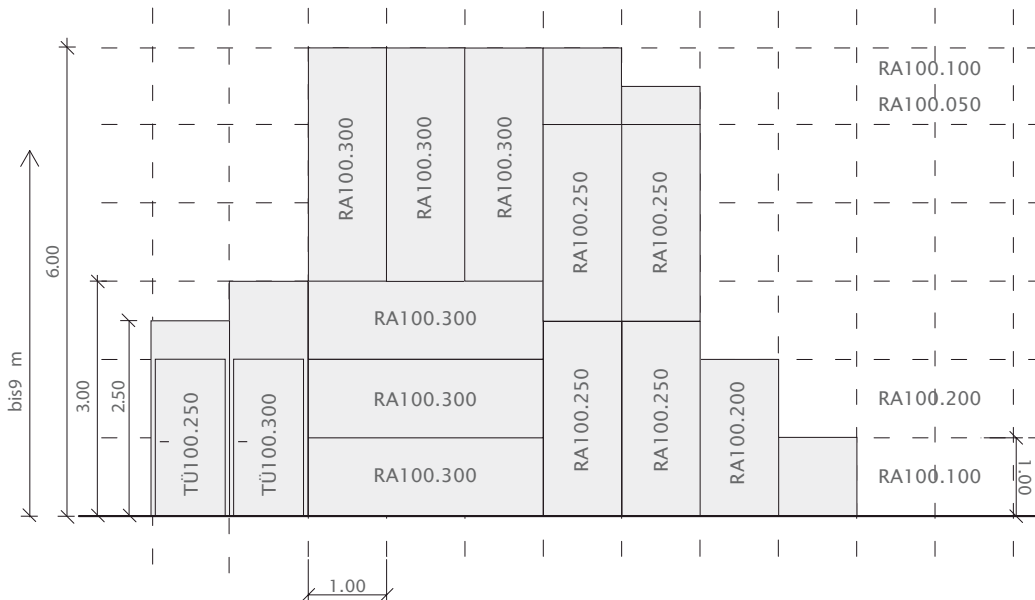

Beispiel Grundriss  
Layout example

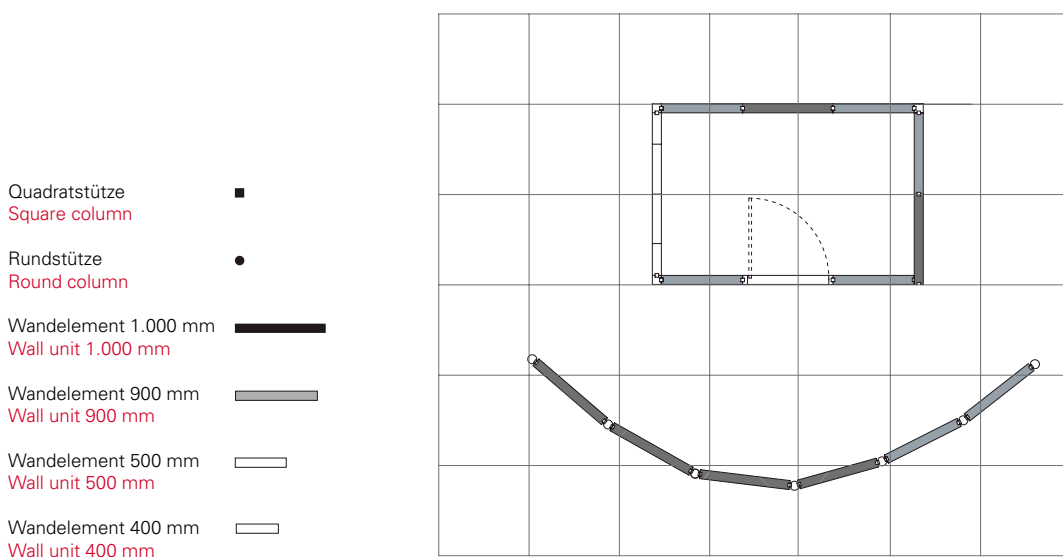

Segmentbau in 11,25°-Schritten  
Segments in 11,25°-steps

Segmentabwicklung mit Keilleisten 0° – 180°  
Segments with wedge grib from 0° – 180°

# Übersicht Overview

## Grundrahmen und Zubehör Basic frame and accessory

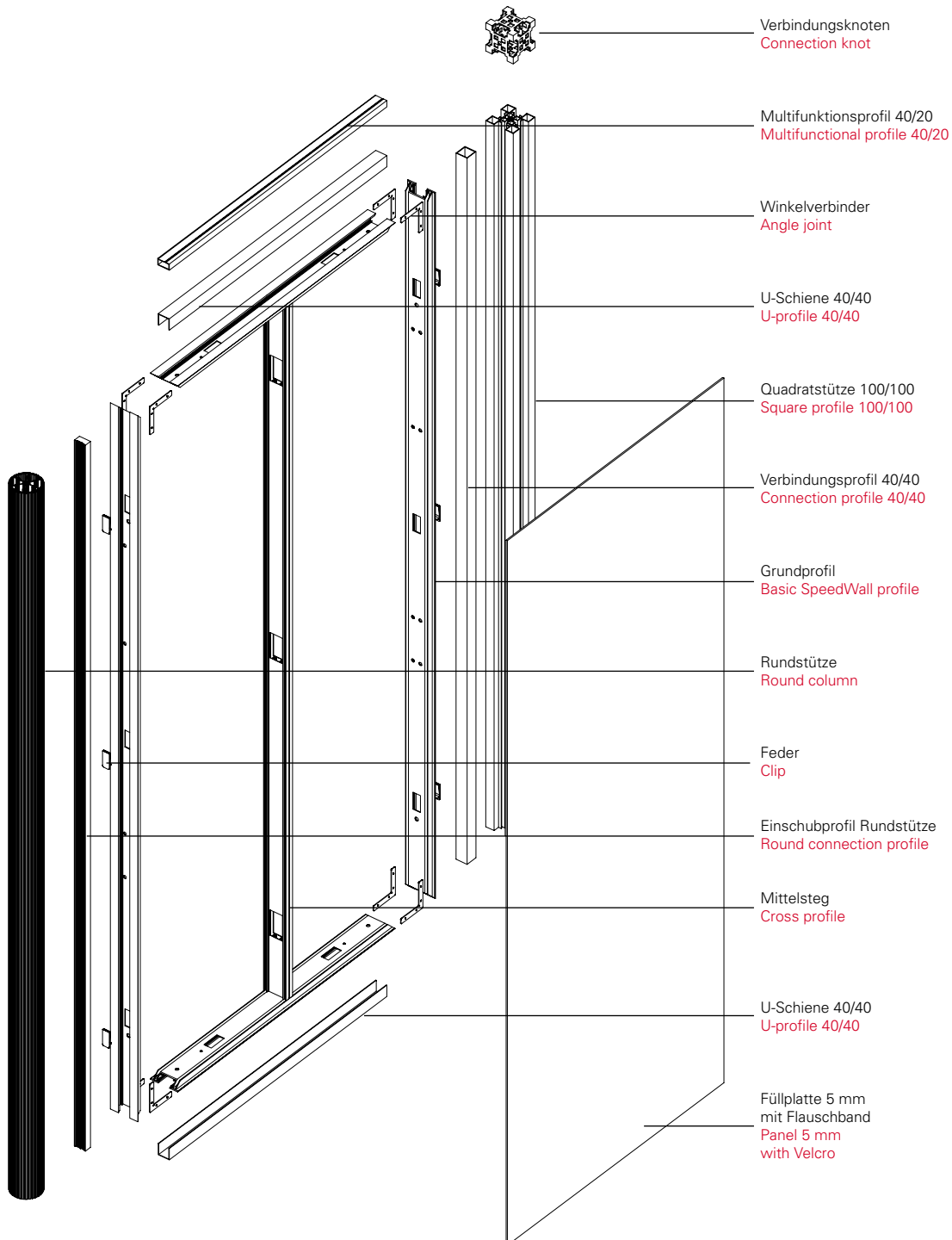

# SpeedWall

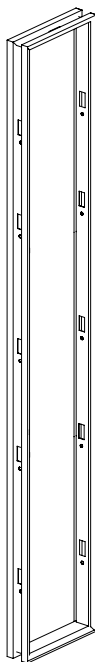
Rahmen  
FramesWandelement 400/100  
Wall Unit 400/100

Breite Width	Höhe Height	Bestell-Nr. Order No.	Stückpreis Price per unit
400 mm	500 mm	RA040.050	172,10 Euro
400 mm	1.000 mm	RA040.100	196,60 Euro
400 mm	2.000 mm	RA040.200	271,90 Euro
400 mm	2.500 mm	RA040.250	314,30 Euro
400 mm	3.000 mm	RA040.300	357,50 Euro

Weitere Maße auf Anfrage. Ohne Zubehör.  
Dissentient dimensions on request. Without Accessories.

Wandelement 500/100  
Wall Unit 500/100

Breite Width	Höhe Height	Bestell-Nr. Order No.	Stückpreis Price per unit
500 mm	500 mm	RA050.050	172,10 Euro
500 mm	1.000 mm	RA050.100	196,60 Euro
500 mm	2.000 mm	RA050.200	271,90 Euro
500 mm	2.500 mm	RA050.250	314,30 Euro
500 mm	3.000 mm	RA050.300	357,50 Euro

Weitere Maße auf Anfrage. Ohne Zubehör.  
Dissentient dimensions on request. Without Accessories.

SpeedWall

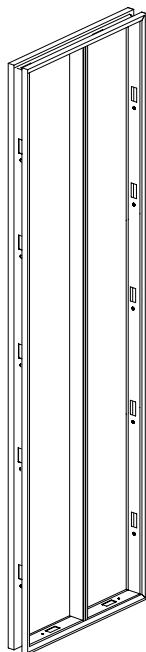
Rahmen  
FramesWandelement 900/100  
Wall Unit 900/100

Breite Width	Höhe Height	Bestell-Nr. Order No.	Stückpreis Price per unit
900 mm	500 mm	RA090.050	196,50 Euro
900 mm	1.000 mm	RA090.100	229,20 Euro
900 mm	2.000 mm	RA090.200	297,40 Euro
900 mm	2.500 mm	RA090.250	371,70 Euro
900 mm	3.000 mm	RA090.300	428,70 Euro

Weitere Maße auf Anfrage. Ohne Zubehör.  
Dissentient dimensions on request. Without Accessories.

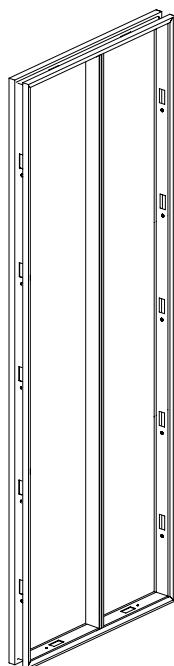
Wandelement 1.000/100  
Wall Unit 1.000/100

Breite Width	Höhe Height	Bestell-Nr. Order No.	Stückpreis Price per unit
1.000 mm	500 mm	RA100.050	196,50 Euro
1.000 mm	1.000 mm	RA100.100	229,20 Euro
1.000 mm	2.000 mm	RA100.200	297,40 Euro
1.000 mm	2.500 mm	RA100.250	371,70 Euro
1.000 mm	3.000 mm	RA100.300	428,70 Euro

Weitere Maße auf Anfrage. Ohne Zubehör.  
Dissentient dimensions on request. Without Accessories.

SpeedWall

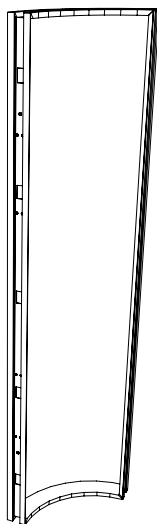
Rahmen  
rund  
Frames  
curvedSpeedWall rund Radius 500  
SpeedWall curved radius 500

Höhe Height	Bestell-Nr. Order No.	Stückpreis Price per unit
500 mm	RAC050.050	438,90 Euro
1.000 mm	RAC050.100	463,70 Euro
2.000 mm	RAC050.200	538,70 Euro
2.500 mm	RAC050.250	581,10 Euro
3.000 mm	RAC050.300	624,30 Euro

Weitere Maße auf Anfrage. Ohne Zubehör.  
Dissentient dimensions on request. Without Accessories.

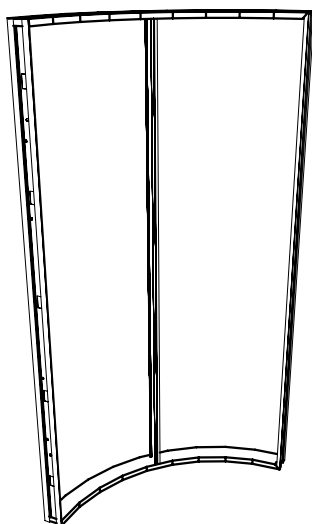
SpeedWall rund Radius 1.000  
SpeedWall curved radius 1.000

Höhe Height	Bestell-Nr. Order No.	Stückpreis Price per unit
500 mm	RAC100.050	495,10 Euro
1.000 mm	RAC100.100	527,80 Euro
2.000 mm	RAC100.200	596,00 Euro
2.500 mm	RAC100.250	670,30 Euro
3.000 mm	RAC100.300	727,30 Euro

Weitere Maße auf Anfrage. Ohne Zubehör.  
Dissentient dimensions on request. Without Accessories.

SpeedWall

## Verbindungsprofil 40/40 Connection profile 40/40

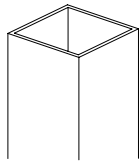

Länge Length	Bestell-Nr. Order No.	Stückpreis Price per unit
500 mm	VP040.050	29,10 Euro
1.000 mm	VP040.100	32,00 Euro
2.000 mm	VP040.200	39,90 Euro
2.500 mm	VP040.250	44,90 Euro
3.000 mm	VP040.300	49,10 Euro

## Aluminiumklettleiste für Wandplatten Velcro-fastening-fillet for panels

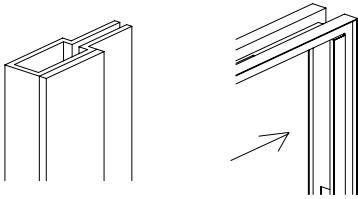

Länge Length	Bestell-Nr. Order No.	Stückpreis Price per unit
500 mm	KW040.050	2,35 Euro
1.000 mm	KW040.100	4,70 Euro
2.000 mm	KW040.200	9,40 Euro
2.500 mm	KW040.250	11,70 Euro
3.000 mm	KW040.300	14,10 Euro

## Hut-Profil Hat-profile

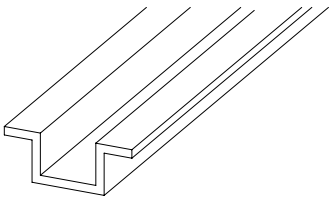

Breite Width	Länge Length	Bestell-Nr. Order No.	Stückpreis Price per unit
23 mm	400 mm	HP000.040	6,20 Euro
23 mm	500 mm	HP000.050	6,80 Euro
23 mm	900 mm	HP000.090	7,90 Euro
23 mm	1.000 mm	HP000.100	8,50 Euro

## Z-Profil Z-profile

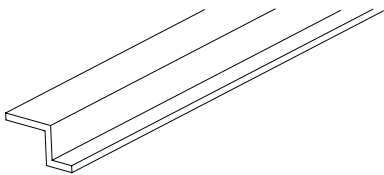

Breite Width	Länge Length	Bestell-Nr. Order No.	Stückpreis Price per unit
16,5 mm	400 mm	ZP000.040	6,10 Euro
16,5 mm	500 mm	ZP000.050	6,70 Euro
16,5 mm	900 mm	ZP000.090	7,80 Euro
16,5 mm	1.000 mm	ZP000.100	8,50 Euro

## U-Schiene 40/40 U-profile 40/40

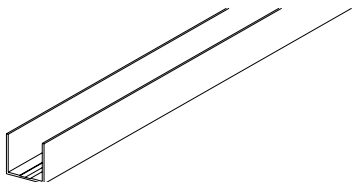

Breite Width	Länge Length	Bestell-Nr. Order No.	Stückpreis Price per unit
40 mm	400 mm	UP000.040	5,35 Euro
40 mm	500 mm	UP000.050	6,55 Euro
40 mm	900 mm	UP000.090	11,50 Euro
40 mm	1.000 mm	UP000.100	12,70 Euro

Alle Profile stufenlos bis 6.000 mm auf Anfrage lieferbar.  
All profiles available up to 6.000 mm infinitely variable on request.

# Profile Profiles

# SpeedWall

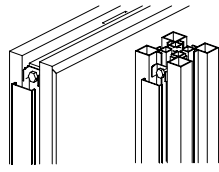

## Abdeckprofil Cover cap profile

Breite Width	Länge Length	Bestell-Nr. Order No.	Stückpreis Price per unit
20 mm	500 mm	AP020.050	6,15 Euro
20 mm	1.000 mm	AP020.100	9,10 Euro
20 mm	2.000 mm	AP020.200	12,80 Euro
20 mm	2.500 mm	AP020.250	14,70 Euro
20 mm	3.000 mm	AP020.300	16,60 Euro

Halterung Abdeckprofil Clamp cover cap	KP000.100	7,00 Euro
---	-----------	-----------

M 8 Gewindekanal  
Gewicht: 4.483 g/m. Anschluß alle 90°  
M 8 thread Weight: 4.483 g/m.  
Connection  
each 90°

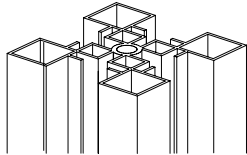

## Quadratstütze 100/100 Square profile 100/100

Länge Length	Bestell-Nr. Order No.	Stückpreis Price per unit
500 mm	ST100.050	32,40 Euro
1.000 mm	ST100.100	64,80 Euro
2.000 mm	ST100.200	129,60 Euro
2.500 mm	ST100.250	162,00 Euro
3.000 mm	ST100.300	194,40 Euro

## Verbindungsknoten V2A Connection knot V2A

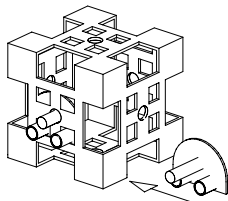

Breite Width	Länge Length	Bestell-Nr. Order No.	Stückpreis Price per unit
100 mm	100 mm	VK100.100	72,00 Euro

Schraubhalterung Screwclamp	SH020.100	13,60 Euro
--------------------------------	-----------	------------

## Rundstütze Ø 100 mm Round column Ø 100 mm

Gewicht:  
5.463 g pro lfdm.  
Anschluß  
alle 11,25°  
Weight:  
5.463 g p. m.  
Connection  
each 11,25°

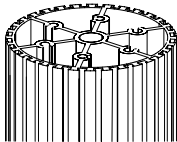

Länge Length	Bestell-Nr. Order No.	Stückpreis Price per unit
1.000 mm	RS100.100	71,50 Euro
2.000 mm	RS100.200	143,00 Euro
2.500 mm	RS100.250	178,70 Euro
3.000 mm	RS100.300	214,50 Euro

## Einschubprofil für Rundstütze Insertion profile for round column

Gewicht: 691 g pro lfdm.  
Weight: 691 g p. m.

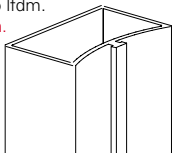

Länge Length	Bestell-Nr. Order No.	Stückpreis Price per unit
1.000 mm	VR100.100	22,40 Euro
2.000 mm	VR100.200	45,10 Euro
2.500 mm	VR100.250	56,40 Euro
3.000 mm	VR100.300	66,50 Euro

Alle Profile stufenlos bis 6.000 mm auf Anfrage lieferbar.  
All profiles available up to 6.000 mm infinitely variable on request.

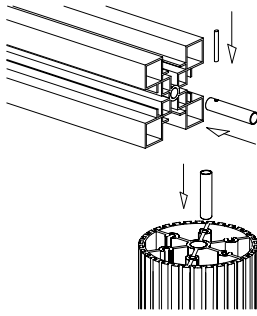

## Gewindeträger Thread carrier

Quadratprofil  
Square profile  
Rundstütze  
Round column

Bestell-Nr. Order No.	Stückpreis Price per unit
TQ000.060	11,20 Euro
TR000.100	11,20 Euro

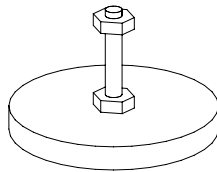

## Verstellfuß Ø 100 mm V2A Adjusting foot Ø 100 mm V2A

Bestell-Nr. Order No.	Stückpreis Price per unit
VF000.100	17,50 Euro

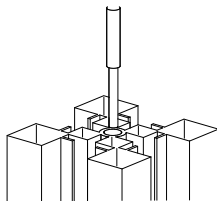

## Verbindung Rundstütze/Quadratprofil Connection round column/square profile

Bestell-Nr. Order No.	Stückpreis Price per unit
SV000.100	12,90 Euro

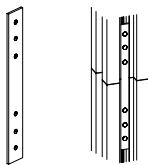

## Träger-, Stützenverbinder 180° Truss, column joint 180°

Länge Length	Bestell-Nr. Order No.	Stückpreis Price per unit
300 mm	TV000.001	34,00 Euro

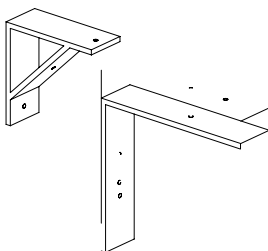

## Winkel Angle truss

	Bestell-Nr. Order No.	Stückpreis Price per unit
klein (60/60) small (60/60)	WT050.060	5,10 Euro
groß (200/200) big (200/200)	WT050.100	24,80 Euro

Alle Profile stufenlos bis 6.000 mm auf Anfrage lieferbar.  
All profiles available up to 6.000 mm infinitely variable on request.

# Stützen Columns

# SpeedWall

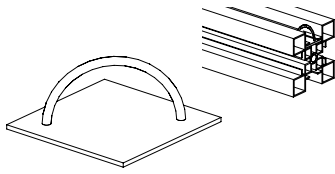

### Abhänger für Träger V2A Hanger for truss V2A

Bestell-Nr. Order No.	Stückpreis Price per unit
KH050.050	46,00 Euro

Taschenfräsung 40/20  
Cut out 40/20

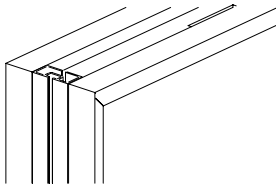

### Einschiebepprofil für Wandrahmen Insertion profile for wallframe

Länge Length	Bestell-Nr. Order No.	Stückpreis Price per unit
500 mm	AN020.050	16,00 Euro
1.000 mm	AN020.100	32,00 Euro
2.000 mm	AN020.200	39,90 Euro
2.500 mm	AN020.250	44,90 Euro
3.000 mm	AN020.300	49,10 Euro

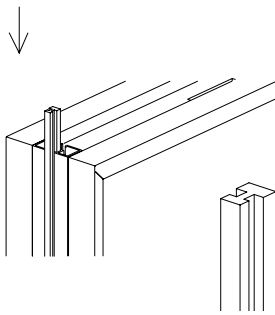

### Verbindungsprofil Kunststoff Connection-profile plastic

Länge Length	Bestell-Nr. Order No.	Stückpreis Price per unit
500 mm	VK000.050	1,16 Euro
1.000 mm	VK000.100	2,20 Euro
2.000 mm	VK000.200	3,40 Euro
2.500 mm	VK000.250	5,20 Euro
3.000 mm	VK000.300	7,80 Euro

### Zargenprofil 20/100 mm Frame-part-profile 20/100 mm

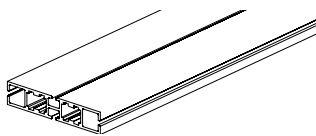

Länge Length	Bestell-Nr. Order No.	Stückpreis Price per unit
500 mm	VK000.050	37,40 Euro
1.000 mm	VK000.100	46,10 Euro
2.000 mm	VK000.200	63,50 Euro
2.500 mm	VK000.250	72,20 Euro
3.000 mm	VK000.300	80,90 Euro

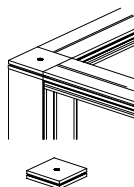

### Rechteckanschluss für Zargenprofil Rectangle connection to frame-part-profile

Bestell-Nr. Order No.	Stückpreis Price per unit
ZP100.110	49,00 Euro

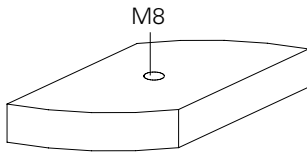

### Nutenstein für Befestigungskanal Slot nut for profile channel

Bestell-Nr. Order No.	Stückpreis Price per unit
HM100.010	6,30 Euro

StahlfüÙe mit Bohrungen für die Befestigung freistehender Wände.  
Steel feet with drill holes for fixation of free standing walls.

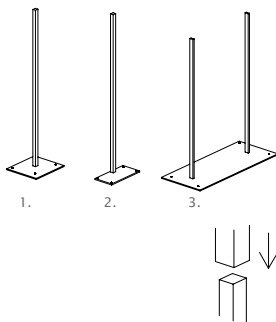

### StahlfüÙe SpeedWall Steel feet SpeedWall

Form Form	Länge Length	Bestell-Nr. Order No.	Stückpreis Price per unit
1	1.000 mm	SF001.100	215,00 Euro
2	1.000 mm	SF002.100	195,00 Euro
3	1.000 mm	SF003.100	322,00 Euro
heavy 1	1.500 mm	SF001.150	385,00 Euro
heavy 2	1.500 mm	SF002.150	350,00 Euro
heavy 3	1.500 mm	SF003.150	579,00 Euro

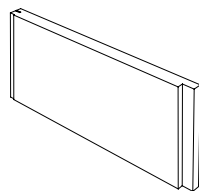

zweiteilig zur Befestigung von LCD Screens o.ä.  
two-piece for mounting LCD screens, etc.

### Verstärkungsplatte Reinforcing Plate

Länge Length	Bestell-Nr. Order No.	Stückpreis Price per unit
900 mm	ZU000.001	29,90 Euro
1.000 mm	ZU000.002	29,90 Euro

## Zubehör Accessories

# SpeedWall

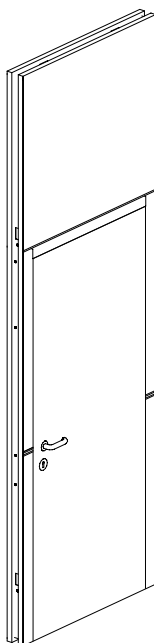
Zubehör  
AccessoriesSystemtür: Zarge, inkl. Oberlicht  
System door: door case, incl. toplight

Breite Width	Länge Length	Bestell-Nr. Order No.	Stückpreis Price per unit
1.000 mm	2.500 mm	ZT100.250	585,00 Euro
1.000 mm	3.000 mm	ZT100.300	635,00 Euro

Systemtür: Türblatt inkl. Garnitur  
System door: door leaf incl. door handle

	Bestell-Nr. Order No.	Stückpreis Price per unit
Holztür weiß DIN 86 Wooden door white DIN 86	TR000.086	185,00 Euro
Glastür Glass door	TR000.186	280,00 Euro
Türanschlag an Quadratstütze Door hinge on square profile	TN000.190	19,90 Euro

SpeedWall



### Feder Clip

Breite Width	Länge Length	Bestell-Nr. Order No.	Stückpreis Price per unit
25 mm	40 mm	FE000.001	1,90 Euro

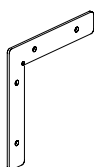

### Winkelverbinder für Grundprofil Angle joint for basic profile

Breite Width	Länge Length	Bestell-Nr. Order No.	Stückpreis Price per unit
100 mm	100 mm	WI000.010	11,20 Euro

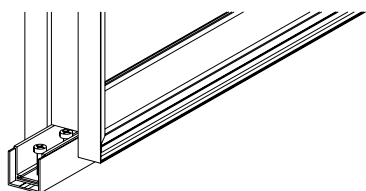

### Stellfuß Adjusting foot

Breite Width	Länge Length	Bestell-Nr. Order No.	Stückpreis Price per unit
40 mm	330 mm	FP000.33	39,00 Euro
40 mm	770 mm	FP000.77	54,00 Euro

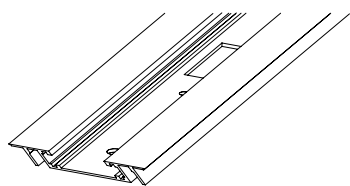

### SpeedWall Grundprofil SpeedWall Basic profile

Breite Width	Länge Length	Bestell-Nr. Order No.	Stückpreis Price per unit
100 mm	400 mm	GR010.040	18,80 Euro
100 mm	500 mm	GR010.050	21,70 Euro
100 mm	900 mm	GR010.090	33,80 Euro
100 mm	1.000 mm	GR010.100	36,90 Euro
100 mm	2.000 mm	GR010.200	65,20 Euro
100 mm	2.500 mm	GR010.250	75,90 Euro
100 mm	3.000 mm	GR010.300	86,80 Euro

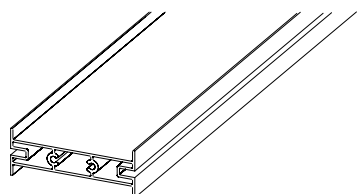

### Mittelsteg 80 Cross profile 80

Breite Width	Länge Length	Bestell-Nr. Order No.	Stückpreis Price per unit
80 mm	1.000 mm	QP008.100	35,90 Euro
80 mm	2.000 mm	QP008.200	58,60 Euro
80 mm	2.500 mm	QP008.250	74,10 Euro
80 mm	3.000 mm	QP008.300	81,60 Euro

# Zubehör Accessories

# SpeedWall

# Grafik- Füllplatten

## Graphic Panels

Inkl. Kaschierung auf  
vorhandene Füllplatte  
Incl. Lamination

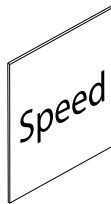

### 4c Digitaldruck auf Folie 4c digital foil print

Bestell-Nr. Order No.	Preis pro m <sup>2</sup> Price per m <sup>2</sup>
DR000.001	89,00 Euro

4c Digitaldruck  
auf 210 g/m<sup>2</sup>  
Stretch Stoff  
4c digitalprint  
on 210 g/m<sup>2</sup>  
stretch fabric

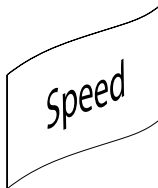

### SpeedWall Stretch Stoff SpeedWall stretch fabric

bedruckt  
printed  
unbedruckt  
blank  
Blackout (einweg)  
Blackout (nonreturnable)  
Blackout mit Flauschband  
Blackout with Velcro tape

Bestell-Nr. Order No.	Preis pro m <sup>2</sup> Price per m <sup>2</sup>
DR000.004	64,00 Euro
DR000.002	48,00 Euro
DR000.006	14,50 Euro
DR000.005	28,00 Euro

Folienkaschierung auf  
vorhandene Füllplatte  
Lamination on  
existing graphic panel

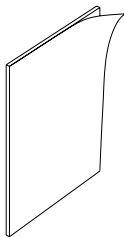

### Folienkaschierung Foil lamination

Bestell-Nr. Order No.	Preis pro m <sup>2</sup> Price per m <sup>2</sup>
DR000.003	24,50 Euro

Zur Befestigung von Drucken  
For fixing digitalprinting

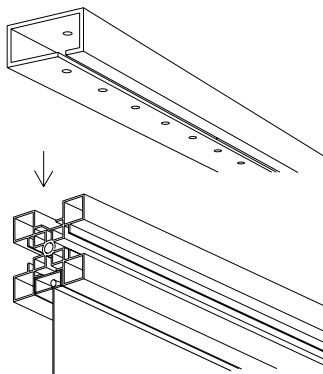

### Multifunktionsprofil 40/20 Multifunctional extrusion 40/20

Länge Length	Bestell-Nr. Order No.	Stückpreis Price per unit
500 mm	AN021.050	6,45 Euro
1.000 mm	AN021.100	12,90 Euro
2.000 mm	AN021.200	25,80 Euro
2.500 mm	AN021.250	32,25 Euro
3.000 mm	AN021.300	38,70 Euro

# SpeedWall

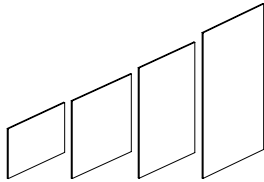

5 mm, weiß oder lichtgrau  
5 mm, white or lightgrey

## Füllplatten HDF 400 Panels HDF 400

Für Rahmen For frame	Maße Measure	Bestell-Nr. Order No.	Stückpreis Price per unit
400 x 500	395 x 495 mm	PL040.050	11,46 Euro
400 x 1.000	395 x 995 mm	PL040.100	15,10 Euro
400 x 2.000	395 x 1.995 mm	PL040.200	22,04 Euro
400 x 2.500	395 x 2.495 mm	PL040.250	25,69 Euro
400 x 3.000	395 x 2.995 mm	PL040.300	29,33 Euro

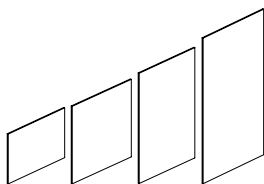

5 mm, weiß oder lichtgrau  
5 mm, white or lightgrey

## Füllplatten HDF 500 Panels HDF 500

Für Rahmen For frame	Maße Measure	Bestell-Nr. Order No.	Stückpreis Price per unit
500 x 500	495 x 495 mm	PL050.050	11,46 Euro
500 x 1.000	495 x 995 mm	PL050.100	15,10 Euro
500 x 2.000	495 x 1.995 mm	PL050.200	22,04 Euro
500 x 2.500	495 x 2.495 mm	PL050.250	25,69 Euro
500 x 3.000	495 x 2.995 mm	PL050.300	29,33 Euro

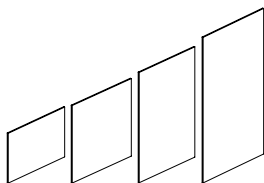

5 mm, weiß oder lichtgrau  
5 mm, white or lightgrey

## Füllplatten HDF 900 Panels HDF 900

Für Rahmen For frame	Maße Measure	Bestell-Nr. Order No.	Stückpreis Price per unit
900 x 500	895 x 495 mm	PL090.050	15,10 Euro
900 x 1.000	895 x 995 mm	PL090.100	21,58 Euro
900 x 2.000	895 x 1.995 mm	PL090.200	32,85 Euro
900 x 2.500	895 x 2.495 mm	PL090.250	38,89 Euro
900 x 3.000	895 x 2.995 mm	PL090.300	44,92 Euro

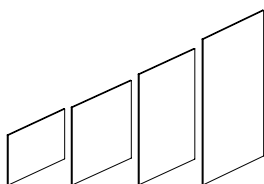

5 mm, weiß oder lichtgrau  
5 mm, white or lightgrey

## Füllplatten HDF 1.000 Panels HDF 1.000

Für Rahmen For frame	Maße Measure	Bestell-Nr. Order No.	Stückpreis Price per unit
1.000 x 500	995 x 495 mm	PL100.050	15,10 Euro
1.000 x 1.000	995 x 995 mm	PL100.100	21,58 Euro
1.000 x 2.000	995 x 1.995 mm	PL100.200	32,85 Euro
1.000 x 2.500	995 x 2.495 mm	PL100.250	38,89 Euro
1.000 x 3.000	995 x 2.995 mm	PL100.300	44,92 Euro

# Füllplatten Plates

# SpeedWall

# Füllplatten rund Plates curved

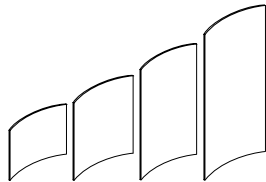

Forex inkl. Folienkaschierung  
Forex incl. foil lamination

## Füllplatten für SpeedWall rund Radius 500 Panels for SpeedWall curved radius 500

Maße Measure	Bestell-Nr. Order No.	Stückpreis Price per unit
780 x 500 mm	PLC050.050	65,40 Euro
780 x 995 mm	PLC050.100	88,50 Euro
780 x 1.995 mm	PLC050.200	135,60 Euro
780 x 2.495 mm	PLC050.250	159,00 Euro
780 x 2.995 mm	PLC050.300	182,00 Euro

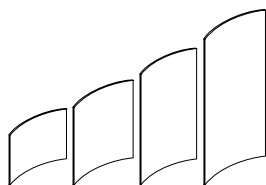

Forex inkl. Folienkaschierung  
Forex incl. foil lamination

## Füllplatten für SpeedWall rund Radius 1.000 Panels for SpeedWall curved radius 1.000

Maße Measure	Bestell-Nr. Order No.	Stückpreis Price per unit
1.565 x 500 mm	PLC100.050	88,80 Euro
1.565 x 995 mm	PLC100.100	135,60 Euro
1.565 x 1.995 mm	PLC100.200	229,20 Euro
1.565 x 2.495 mm	PLC100.250	276,00 Euro
1.565 x 2.995 mm	PLC100.300	322,80 Euro

# SpeedWall

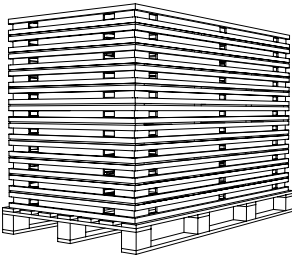

Für 17 Rahmen  
For 17 frames

### SpeedWall Palette SpeedWall palett

Länge Length	Bestell-Nr. Order No.	Stückpreis Price per unit
2.000 mm	ZU000.006	59,00 Euro
2.500 mm	ZU000.007	86,00 Euro
3.000 mm	ZU000.008	95,00 Euro

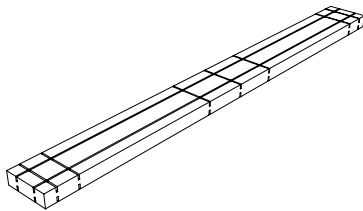

3 Stück pro Rahmen  
3 per frame

### Stapelleisten für Rahmen Frame Slat

Span Chipboard	Genutet Fluted	Bestell-Nr. Order No.	Stückpreis Price per unit
		ZU000.009	2,00 Euro
		ZU000.010	5,80 Euro

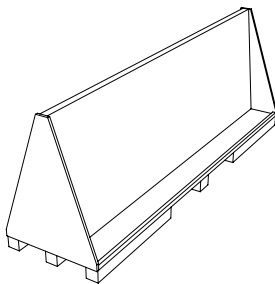

Für bis zu 60 Füllplatten  
For up to 60 panels

### Plattenbock Panel palett

Länge Length	Bestell-Nr. Order No.	Stückpreis Price per unit
2.000 mm	ZU000.003	490,00 Euro
2.500 mm	ZU000.004	599,00 Euro
3.000 mm	ZU000.005	675,00 Euro

Transport-  
einheiten  
Transport-  
units

SpeedWall